

MZ7TFT

Installation and Operation Manual

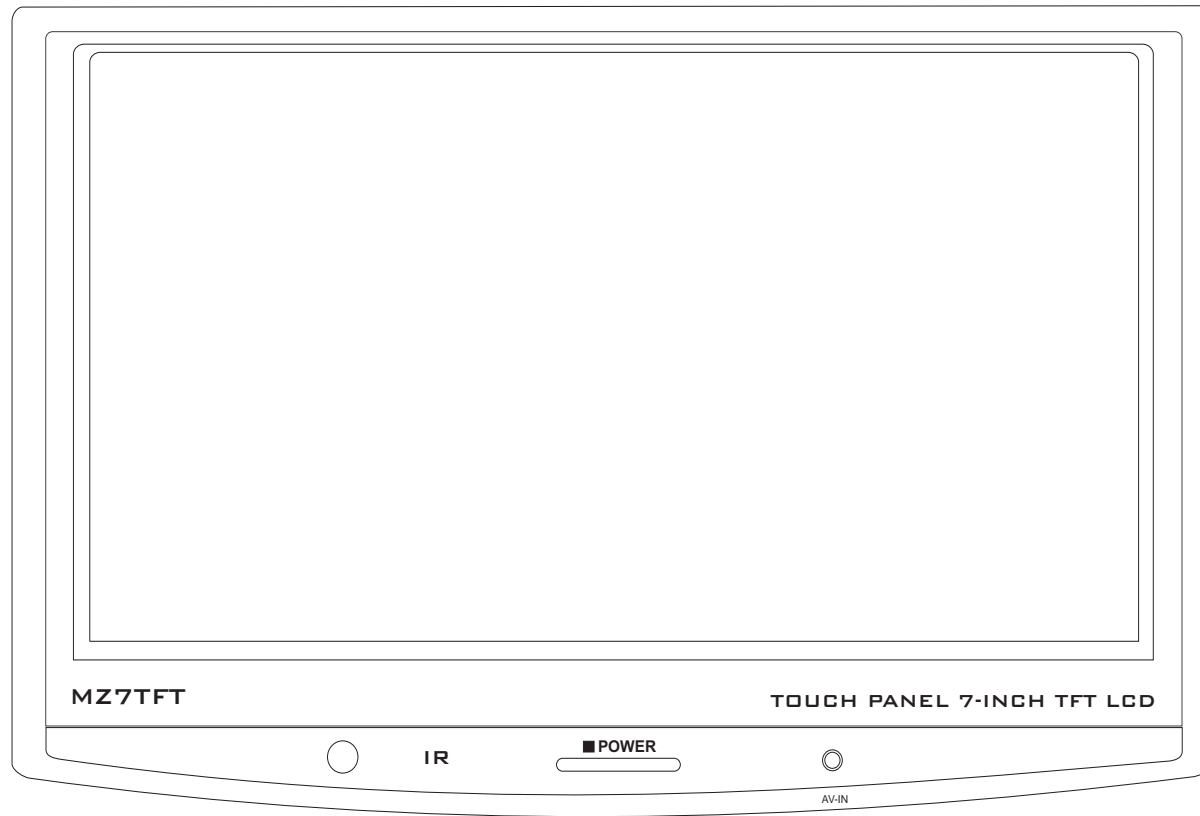

Introduction

Thank you for purchasing the Audiovox MZ7TFT Touch Screen Monitor. This package contains (1) one MZ7TFT, Installation and Operation Manual, mounting bracket with tool, wiring harness, touch screen expansion module and a three year limited warranty.

Toll-Free Installation Assistance

If you require assistance, contact Technical Support at 1-800-645-4994 from 9:00 a.m. to 6:00 p.m. EST Monday through Friday (U.S.A. and Canada only).

Wiring

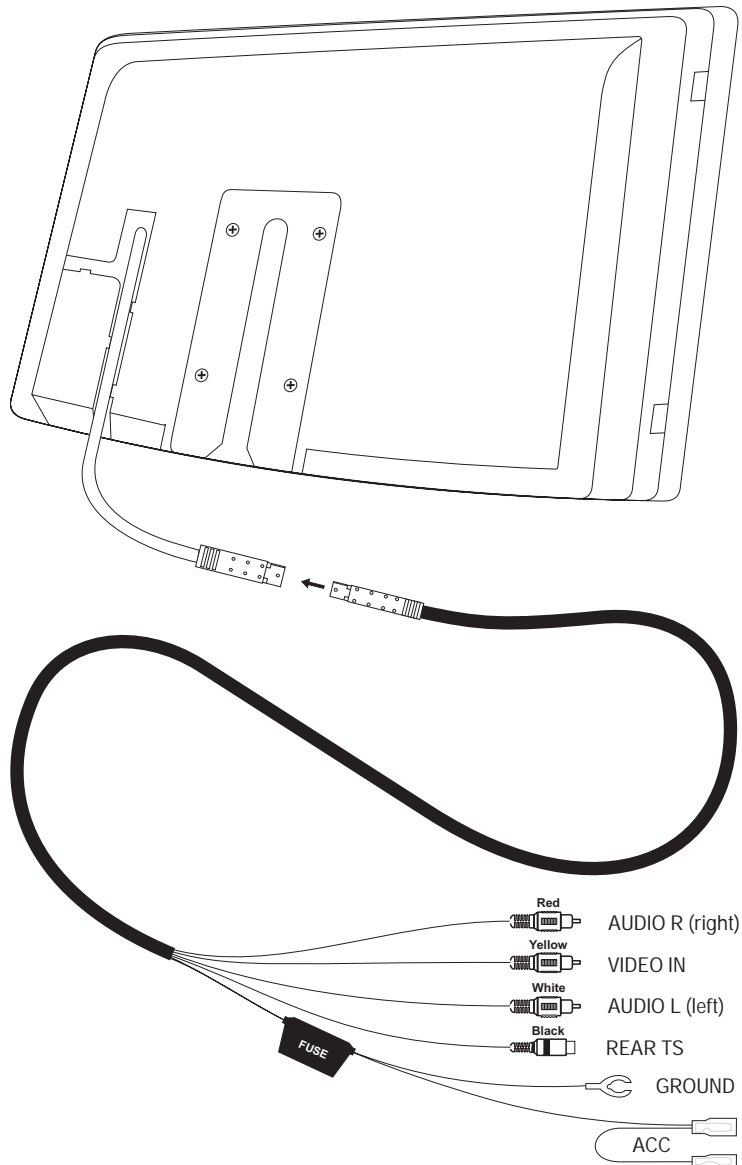

Figure 1: Wiring Connections

1. Align the ridges on either end of the combined input cable (VIDEO IN, AUDIO L, AUDIO R, REAR TS, GROUND and ACC) and connect the cable to the male connector on the back of the MZ7TFT. The connector will only fit when the notched areas are properly aligned.
2. Connect the REAR TS connector to the MZ7-TFT connector on the back of your compatible head unit (if applicable).

NOTE: You can connect up to three monitors to your compatible head unit using the Touch Screen Expansion Module (included). See "Touch Screen Expansion Module" on page 4 for instructions.

3. Connect the AUDIO R, AUDIO L and VIDEO IN connectors to the Video and Audio output (Headphone Multizone) cables on the back of your compatible head unit or to another auxiliary device for which you would like to output video.
4. Connect the black GROUND wire to the factory ground wire on your head unit, or to a clean, unpainted metal part of the automobile chassis using a ring terminal and a sheet metal screw.
5. Connect the ACC wire to the factory accessory or ignition wire, which receives power when the key is turned on.

Touch Screen Expansion Module

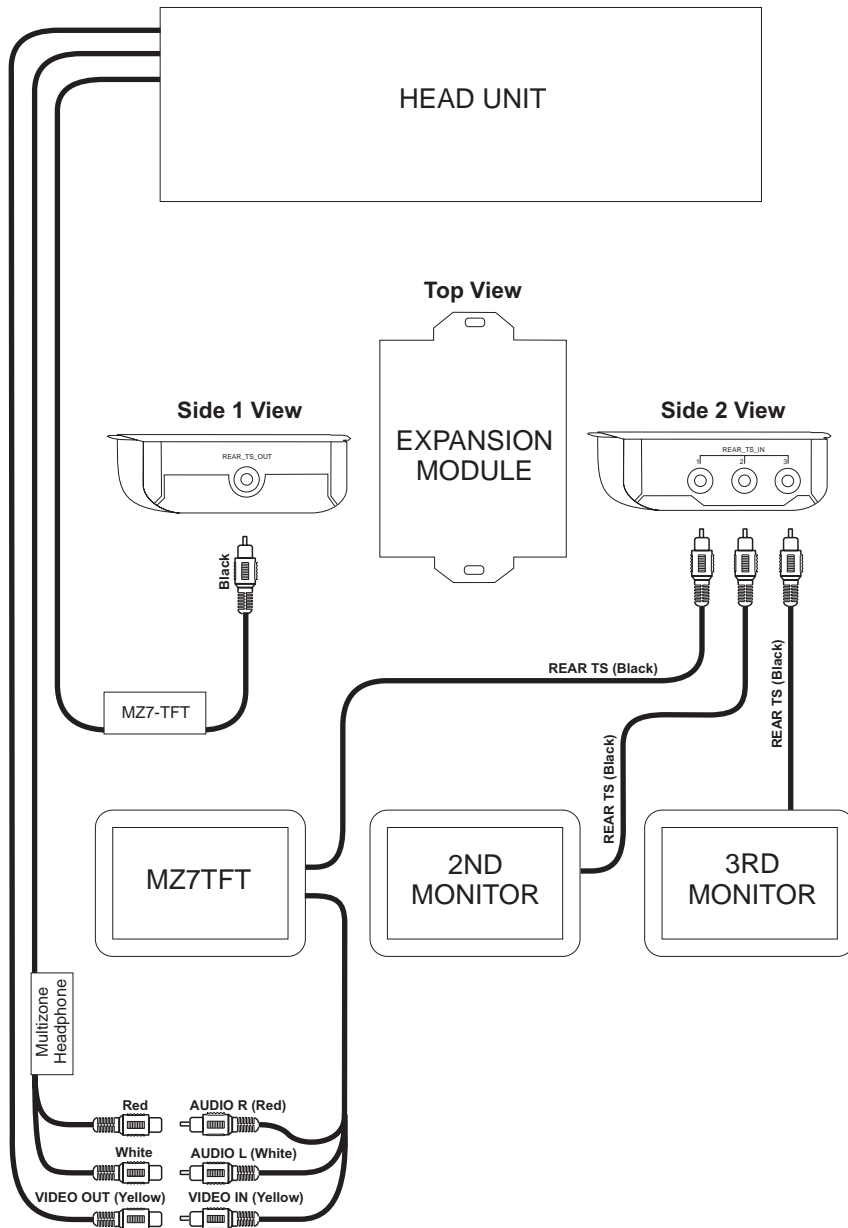

1. Connect the AUDIO R and AUDIO L cables from the MZ7TFT to the Multizone Headphone cables on the back of your compatible head unit.
2. Connect the VIDEO IN cable from the MZ7TFT to the Video Out cable on the back of your compatible head unit.
3. Connect the MZ7-TFT connector from the back of your compatible head unit to the REAR_TS_OUT connector on Side 1 of the Expansion Module.
4. Connect the REAR TS connector from the back of the MZ7TFT to the REAR_TS_IN 1 connector on Side 2 of the Expansion Module.
5. Connect the REAR TS connectors for additional TFT screens to the REAR_TS_IN 2 and 3 connectors.

NOTE: The touchscreen feature of the MZ7TFT is compatible only with a receiver with an MZ7-TFT output connector. Otherwise the "Touch Screen" function will not operate.

Installation/Mounting

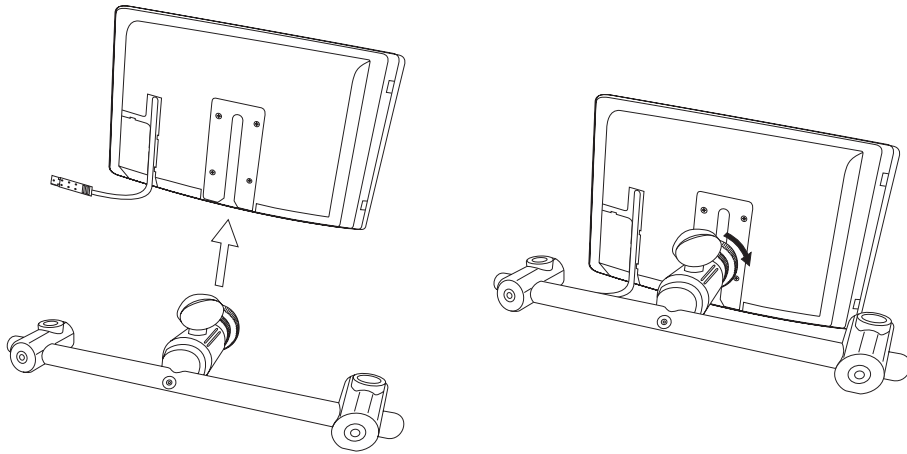

Figure 2: Attach Bracket/Secure Bracket

1. Insert the metal end of the center arm on the mounting bracket into the slot on the back of the monitor.
2. Turn the large plastic nut to secure the bracket to the monitor.
3. Tighten the smaller plastic nut to further secure the bracket.
4. Install the headrest through the holes in the headrest mounting pieces on either end of the mounting bracket.
5. Use the Allen wrench provided to loosen the headrest mounting pieces on either end and rotate, if necessary, to achieve the appropriate depth.
6. Use the Allen wrench provided to secure the headrest mounting pieces to the headrest poles.
7. Position the monitor at the desired angle, and then use the Allen wrench to tighten the other side of the headrest mounting pieces and prevent them from rotating.
8. Once installed, use the knob on the top of the center arm of the mounting bracket to tilt or rotate the monitor. Tighten when finished.

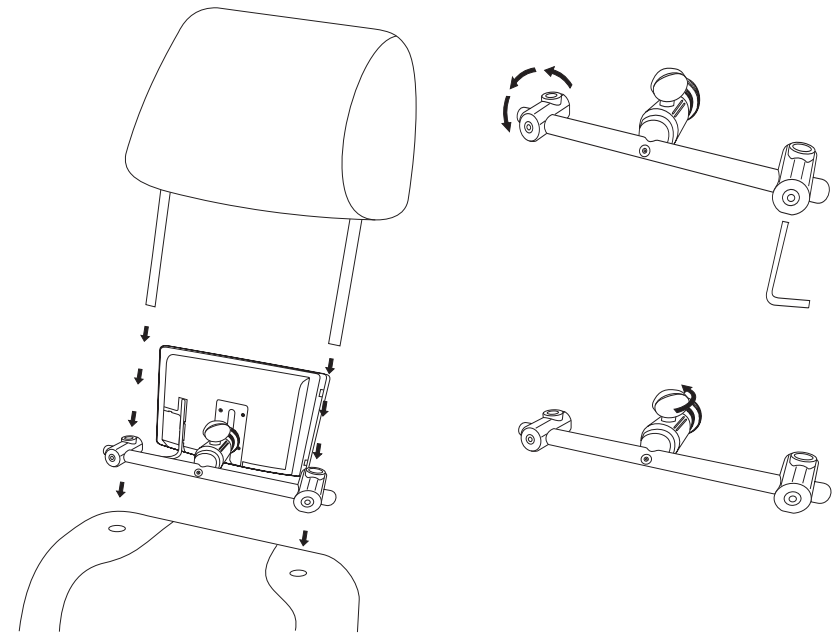

Figure 3: Install Headrest/Tighten and Adjust

Operation

Power On/Off/Standby

The input allows voltage ranges from DC 10.8V to 16V, which includes the DC 12V car power supply.

After connecting the power, the monitor will be in standby mode. Press the **POWER** button to turn the monitor on. *Press and hold* the **POWER** button to return the unit to standby mode.

Controls and Indicators

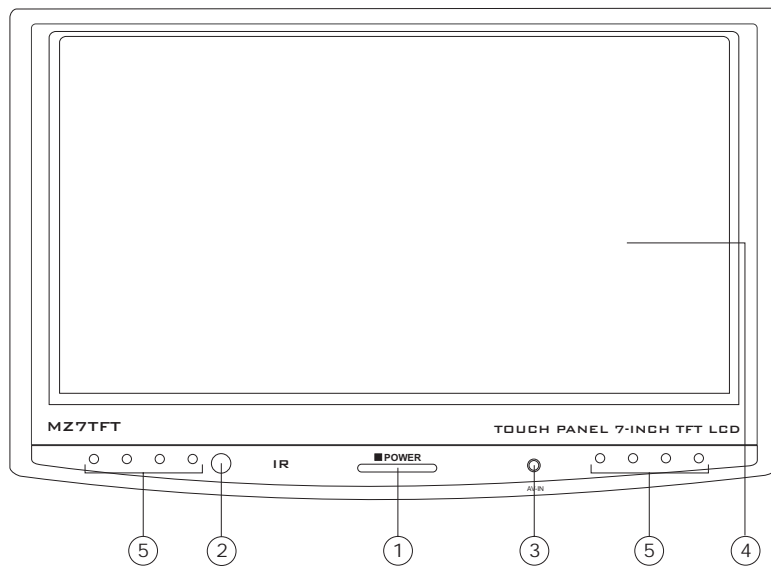

Figure 4: Front Panel Controls

1. **POWER:** Red illumination indicates standby mode, blue indicates working state.

NOTE: The LCD backlight will turn off after 10 seconds without signal input.

2. **IR:** Remote signal repeater allows you to control your compatible head unit using the head unit's remote control.

NOTE: Your head unit must be compatible with the MZ7TFT touch screen capability for the IR remote repeater function to work.

3. **AV-IN:** Audio/video input connector (AUX AV IN).
4. **Touch Screen**
5. **Infrared Transmitter Array:** Do not block or cover this area, as it will affect audio transmission to headphones.

NOTE: Your head unit must be compatible with the MZ7TFT touch screen capability for the Touch Screen function to work.

IR Interference

When used in or near direct sunlight, you may experience loud background noise or a low audio signal. This is inherent in Infrared Ray communication and does not mean there is a problem with the MZ7TFT itself.

If you use the MZ7TFT by a window with bright sunlight, draw the curtains/blinds to shut out the direct sunlight, or use the MZ7TFT away from the sunlight.

Menu Operation

While the monitor is turned on, press the **POWER** button to access the "MAIN MENU" on the MZ7TFT screen. Touch a main menu selection to see the corresponding sub-menu.

- **EXIT:** To exit the menu from any level, touch the **EXIT** option on screen.
- **PICTURE:** Adjust the Brightness, Color, Contrast or Tint from -15 to +15.
- **FUNCTION**
 - BLUE SCREEN (ON/OFF)
 - VIDEO IMAGE (NORMAL/IMAGE (MIRROR))
 - DISPLAY MODE (NORMAL/FULL)
 - AUTO DIMMER (ON/OFF): Useful for Daytime/Nighttime viewing
 - DIMMER SCOPE (-30 to 0), -30 being more dim
- **SOURCE**
 - SOURCE (AV1/AUX AV IN):
 - IR AUDIO (A/B/OFF): If there is more than one (1) MZ7TFT in use simultaneously, each headphone must be set to receive on a different

channel, and each MZ7TFT must be set to transmit on the same channel as the headphone (i.e., left seat monitor/headphones set to channel A and right seat monitor/headphones set to channel B). This will prevent interference of audio by the IR signal being transmitted from two monitors on the same channel. This is inherent in Infrared Ray communication and does not mean there is a problem with the MZ7TFT itself.

- **SCREEN ADJUST**

Selecting the Input Signal

The unit is provided with a AV-IN jack on the front of the monitor, as well as AV1 inputs for your headphone unit or other device with composite video and line level audio output.

When connecting the monitor to an alternate A/V device, you can plug an A/V cable (Figure 5) into the AV-IN input jack, and then plug the red, white and yellow RCA connectors into your A/V device.

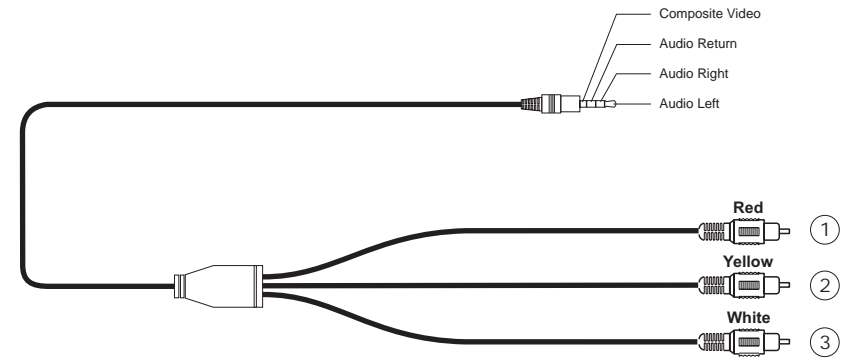

Figure 5: A/V Cable (not included)

1. Audio Input 1
2. Audio Input 2
3. Composite Video

After connecting a device using an A/V Adapter Cable, press the **POWER** button on the front of the monitor to access the MAIN MENU. Select **SOURCE** and then select "AUX AV IN" for the SOURCE option.

Care and Maintenance

- Do not remove the rear panel of this product. If in need of service, please call a qualified technician.
- Keep away from strong light while using this product so as to obtain the clearest and the most colorful picture.
- Avoid heavy impact, do not drop.
- Do not use chemical solutions to clean this unit. Please wipe with a clean soft cloth to keep brightness of the surface.
- Do not expose this product to direct sunlight, heat or humid conditions.

Specifications

Video input: 2 channels CVBS

Audio input: 2 channels stereo

Audio output: Infrared modulation

Monitor specification: 7 inch color TFT LCD

Pixel: RGB 234 x 1440

Power: 10.8~16V, Negative grounding

Max. current: 1A

Standby current: $\leq 5\text{mA}$

Video input amplitude: 1v-pp, 75 ohm load

Audio input amplitude: 2Vrms max

Operating temperature: $-10^{\circ}\text{C}\sim+60^{\circ}\text{C}$

IR carrier frequency:

- A Channel: 2.3/2.8MHz $\pm 100\text{ppm}$
- B Channel: 3.2/3.8MHz $\pm 100\text{ppm}$

IR wavelength: 850nm

Modulation mode: Frequency modulation (FM)

Range of IR emitting:

- Frontage: 5m
- Left and right / up and down (30°): 2m

Limited Warranty

DO NOT RETURN THIS PRODUCT TO THE STORE

Audiovox Electronics Corporation (“the Company”) is committed to quality and customer service, and are pleased to offer you this Warranty. Please read it thoroughly and contact the Company at 1-800-323-4815 with any questions.

Who is covered?

The Company extends this warranty to the original retail purchaser of products purchased through an authorized Audiovox retailer in the U.S.A., Puerto Rico or Canada. This warranty is not transferable or assignable. Proof of purchase is required in the form of an original sales receipt.

What is covered?

The Company warrants that should this product or any part thereof, under normal use, be proven defective in material or workmanship within 36 months from the date of original purchase, such defect(s) will be repaired or replaced with a new or reconditioned product (at the Company's option) without charge for parts and repair labor.

What is not covered?

This Warranty *does not* cover the following:

- Damage incurred during shipping or transporting the product to the Company or a service center
- Elimination of car static or motor noise
- Defects in cosmetic, decorative or non-operative structural parts
- Correction of antenna problems
- Costs incurred for installation, removal or reinstallation of the product
- Consequential damage to compact discs, USB devices, digital media cards, accessories or vehicle electrical systems
- Damage caused by improper installation, mishandling, misuse, neglect, accident, blown fuse, battery leakage, theft or improper storage
- Products whose factory serial number/bar code label(s) or markings have been removed or defaced
- Damage resulting from moisture, humidity, excessive temperature, extreme environmental conditions or external natural causes

Please review the “Care and Maintenance” section of your Installation and Operation Manual for additional information regarding the proper use of your product.

Limitations

THE EXTENT OF THE COMPANY'S LIABILITY UNDER THIS WARRANTY IS LIMITED TO THE REPAIR OR REPLACEMENT PROVIDED ABOVE AND, IN NO EVENT, SHALL THE COMPANY'S LIABILITY EXCEED THE PURCHASE PRICE PAID BY PURCHASER FOR THE PRODUCT.

This Warranty is in lieu of all other express warranties or liabilities. ANY IMPLIED WARRANTIES, INCLUDING ANY IMPLIED WARRANTY OF MERCHANTABILITY, SHALL BE LIMITED TO THE DURATION OF THIS WRITTEN WARRANTY. ANY ACTION FOR BREACH OF ANY WARRANTY HEREUNDER INCLUDING ANY IMPLIED WARRANTY OF MERCHANTABILITY MUST BE BROUGHT WITHIN A PERIOD OF 36 MONTHS FROM DATE OF ORIGINAL PURCHASE. IN NO CASE SHALL THE COMPANY BE LIABLE FOR ANY CONSEQUENTIAL OR INCIDENTAL DAMAGES FOR BREACH OF THIS OR ANY OTHER WARRANTY, EXPRESS OR IMPLIED, WHATSOEVER. No person or representative is authorized to assume for the Company any liability other than expressed herein in connection with the sale of this product.

Some states do not allow limitations on how long an implied warranty lasts or the exclusion or limitation of incidental or consequential damage so the above limitations or exclusions may not apply to you. This Warranty gives you specific legal rights and you may also have other rights which vary from state to state.

Obtaining Warranty Service

- To obtain repair or replacement within the terms of this Warranty, call 1-800-323-4815 for the location of a warranty station serving your area.
- You must prepay the initial shipping charges to the Company. The Company will pay the return shipping charges for all warranted products returned to an address within the U.S.A., Puerto Rico or Canada.
- Please package the product securely to avoid shipping damage. We recommend using a carrier that provides tracking service to prevent lost packages. Lost or damaged packages are not covered by this warranty.
- Provide a detailed description of the problem(s) for which you require service.



Audiovox Electronics Corporation
Hauppauge, NY 11788
Technical Assistance: 1-800-645-4994
www.audiovox.com

© 2008 Audiovox
Ver. 121907
Printed in China